

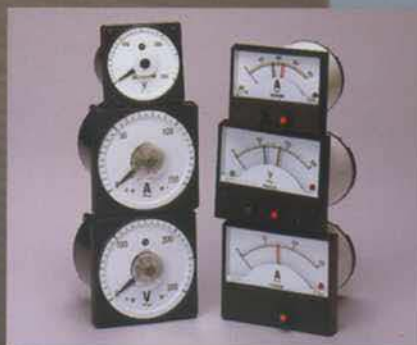







Panel Instruments Cts & Shunts



INDEX

- DIN PANEL METERS (For A.C. ) 3
- DIN PANEL METERS (For D.C. ) 4
- DRAWING OF DIALS 5
- REEDS/POINTER, FREQUENCY METERS  6
- MAXIMUM DEMAND, BIMETALLIC PANEL METER  6
- POWER FACTOR METER (COS ϕ METERS)  7
- PANEL AMMETERS AND VOLTMETERS 8
- WATTMETERS (active power)  9
- VAR METERS (reactive power)  10
- ANALOG METER RELAY 11
- LONG SCALE INSTRUMENT 12
- OVERALL DIMENSIONS 13

The Company can modify the specification at any time without having to give notice.



ONLINE CERTIFICATIONS DIRECTORY

PICQ2.E327849

Measuring, Testing and Signal Generation Equipment - Component

Page Bottom

Measuring, Testing and Signal Generation Equipment - Component

See General Information for Measuring, Testing and Signal Generation Equipment - Component

TAIWAN METERS PLANT CO LTD
ROOM 3C-15, TAIPEI WORLD TRADE CENTER
5 HSIN YI RD SEC 5
TAIPEI, 110 TAIWAN

E327849

AC Ammeter, Model BP-45 Series.

AC Ammeters, Voltmeters and Frequency Meters, Models BE-72 Series, BP-45 Series.

AC Ammeters, AC Voltmeters, DC Ammeters, DC Voltmeters and AC Frequency meters, Models BE-96 Series, LS-80 Series.

DC Ammeter, Model BP-50S Series.

DC Ammeters and Voltmeters, Models BP-65 Series, BP-50S Series.

Marking: Company name, model designation and the Recognized Component Mark 
Last Updated on 2009-02-16

[Questions?](#)

[Notice of Disclaimer](#)

[Page Top](#)

Copyright © 2009 Underwriters Laboratories Inc. ®

The appearance of a company's name or product in this database does not in itself assure that products so identified have been manufactured under UL's Follow-Up Service. Only those products bearing the UL Mark should be considered to be Listed and covered under UL's Follow-Up Service. Always look for the Mark on the product.

UL permits the reproduction of the material contained in the Online Certification Directory subject to the following conditions: 1. The Guide Information, Designs and/or Listings (files) must be presented in their entirety and in a non-misleading manner, without any manipulation of the data (or drawings). 2. The statement "Reprinted from the Online Certifications Directory with permission from Underwriters Laboratories Inc." must appear adjacent to the extracted material. In addition, the reprinted material must include a copyright notice in the following format: "Copyright © 2009 Underwriters Laboratories Inc.®"

An independent organization working for a safer world with integrity, precision and knowledge.



30 YEARS OF TRADITION, TECHNOLOGY AND QUALITY

Analogue panel meters



*  Taiwan Meters Plant is one of the largest independent Taiwanese manufacturers of Panel Meters, Current Transformers and shunts in Taiwan.

* 30 years experience in the Automation Industry,  products have built a reputation for high quality and modern design at competitive prices. The company is export oriented, 90% of products are sold world-wide.

* The current catalogues provide a survey of our efforts and is the main link with our distributors, partners and end users of our products in the field of the measuring technique.

TECHNICAL SPECIFICATION

Standards : IEC 51, BS 89, DIN 43780, VDE 0410.

Enclosure : * ABS & Polycarbonate.
 * Base material UL 94VL,
 * Case & Terminal protection material UL 94VO.
 * The scale division marking DIN 43802. (see drawing of scales,
 Direct, F1, F2, F3 & F5).



















Accuracy : Class 1.5 ($\pm 1.5\%$ max, error)

Overload : Current - 1.2 x I_n or U_n for 2 hours.
 10 x I_n or U_n for 5 seconds.
 Voltage - 1.2 x I_n or U_n for 2 hours.
 2 x I_n or U_n for 5 seconds.

Insulation Test : 2KV 50HZ/60HZ for 1 minute.

Temperature : Working temperature between -25°C and $+50^{\circ}\text{C}$
 (calibrated at 23°C)

SIGNS OF THE INSTRUMENT TECHNICAL CHARACTERISTICS

SIGN	DESCRIPTION	SIGN	DESCRIPTION
	Electronic device in a measure circuit		D.C. circuit.
	Rectifier		A.C. circuit.
	Shunt		D.C. and/or A.C. circuit.
	Additional/ resistor		Testing voltage higher than 500 V (for example 2kV)
	Zero setting device		Instrument to be used with vertical scale
	General accessories		Moving coil for D.C. Instruments
	Ground terminal		Moving Iron for A.C. Instruments
	Positive terminal		Bimetal instrument
	Negative terminal		Vibrating reeds instrument

DIN PANEL METERS (For A.C.)

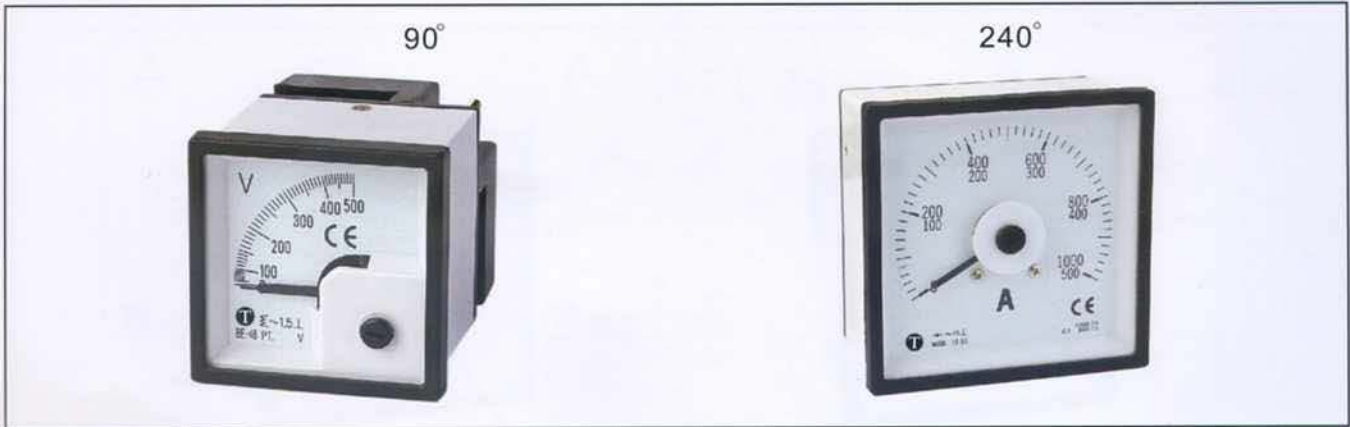

AMMETERS																
Type	BE-48				BE-72				BE-96				BE-144			
Size	48×48mm				72×72mm				96×96mm				144×144mm			
	DIRECT		CT /1A or /5A		DIRECT		CT /1A or /5A		DIRECT		CT /1A or /5A		DIRECT		CT /1A or /5A	
	F1	F2	F1	F2	F1	F2	F1	F2	F1	F2	F1	F2	F1	F2	F1	F2
1A					●○	●					●○	●				
5A	●	●	●	●	●○	●	●○	●	●○	●	●○	●	●	●	●	●
10A	●	●	●	●	●○	●	●○	●	●○	●	●○	●	●	●	●	●
15A	●	●	●	●	●○	●	●○	●	●○	●	●○	●	●	●	●	●
20A	●	●	●	●	●○	●	●○	●	●○	●	●○	●	●	●	●	●
25A	●	●	●	●	●○	●	●○	●	●○	●	●○	●	●	●	●	●
30A	●	●	●	●	●○	●	●○	●	●○	●	●○	●	●	●	●	●
40A	●	●	●	●	●○	●	●○	●	●○	●	●○	●	●	●	●	●
50A			●	●	●○	●	●○	●	●○	●	●○	●	●	●	●	●
60A			●	●	●○	●	●○	●	●○	●	●○	●	●	●	●	●
75A			●	●			●○	●	●○	●	●○	●	●	●	●	●
100A			●	●			●○	●	●○	●	●○	●	●	●	●	●
120A			●	●			●○	●					●	●	●	●
150A			●	●			●○	●			●○	●	●	●	●	●
200A			●	●			●○	●			●○	●	●	●	●	●
250A			●	●			●○	●			●○	●	●	●	●	●
300A			●	●			●○	●			●○	●	●	●	●	●
400A			●	●			●○	●			●○	●	●	●	●	●
500A			●	●			●○	●			●○	●	●	●	●	●
600A			●	●			●○	●			●○	●	●	●	●	●
800A			●	●			●○	●			●○	●	●	●	●	●
1000A			●	●			●○	●			●○	●	●	●	●	●
1200A							●○	●			●○	●				
1250A							●○	●			●○	●				
1500A							●○	●			●○	●			●	●
2000A							●○	●			●○	●			●	●
2500A							●○	●			●○	●			●	●
3000A							●○	●			●○	●			●	●

VOLTMERS				
Type	BE-48	BE-72	BE-96	BE-144
100V	●	●○	●○	●
300V	●	●○	●○	●
500V	●	●○	●○	●
600V		●○	●○	●

● 90°
 ○ 240°
 1. Interchangeable dials
 2. Fixed dials

DIN PANEL METERS (For D.C.)

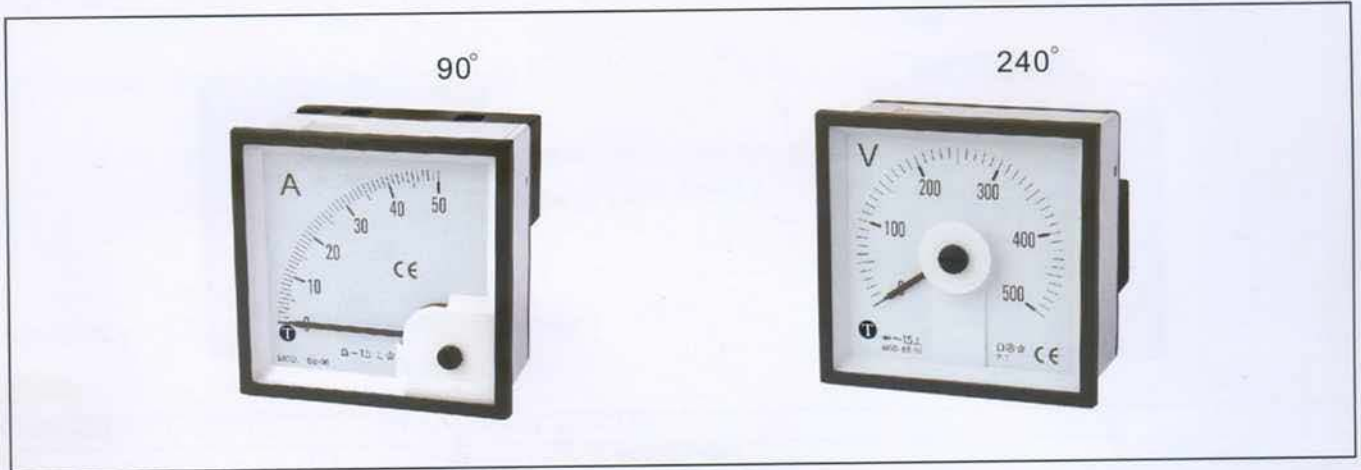

AMMETERS								
Type	BE-48		BE-72		BE-96		BE-144	
Size	48×48mm		72×72mm		96×96mm		144×144mm	
	50,60,75 mV	0 central 50,60,75mV	50,60,75 mV	0 central 50,60,75 mV	50,60,75 mV	0 central 50,60,75 mV	50,60,75 mV	0 central 50,60,75 mV
10A	●	●	●○	●○	●○	●○	●	●
15A	●	●	●○	●○	●○	●○	●	●
20A	●	●	●○	●○	●○	●○	●	●
25A	●	●	●○	●○	●○	●○	●	●
30A	●	●	●○	●○	●○	●○	●	●
40A	●	●	●○	●○	●○	●○	●	●
50A	●	●	●○	●○	●○	●○	●	●
60A	●	●	●○	●○	●○	●○	●	●
80A	●	●	●○	●○	●○	●○	●	●
100A	●	●	●○	●○	●○	●○	●	●
150A	●	●	●○	●○	●○	●○	●	●
200A	●	●	●○	●○	●○	●○	●	●
300A~	●	●	●○	●○	●○	●○	●	●

VOLTMETERS								
Type	BE-48		BE-72		BE-96		BE-144	
Size	48×48mm		72×72mm		96×96mm		144×144mm	
DIRECT		0 central		0 central		0 central		0 central
60mV	●	●	●○	●○	●○	●○	●	●
10V	●	●	●○	●○	●○	●○	●	●
20V	●	●	●○	●○	●○	●○	●	●
40V	●	●	●○	●○	●○	●○	●	●
100V	●	●	●○	●○	●○	●○	●	●
150V	●	●	●○	●○	●○	●○	●	●
200V	●	●	●○	●○	●○	●○	●	●
300V	●	●	●○	●○	●○	●○	●	●
400V	●	●	●○	●○	●○	●○	●	●
500V	●	●	●○	●○	●○	●○	●	●

●	90°	1. Interchangeable dials
○	240°	1. Interchangeable dials 2. Fixed dials

DRAWING OF DIALS

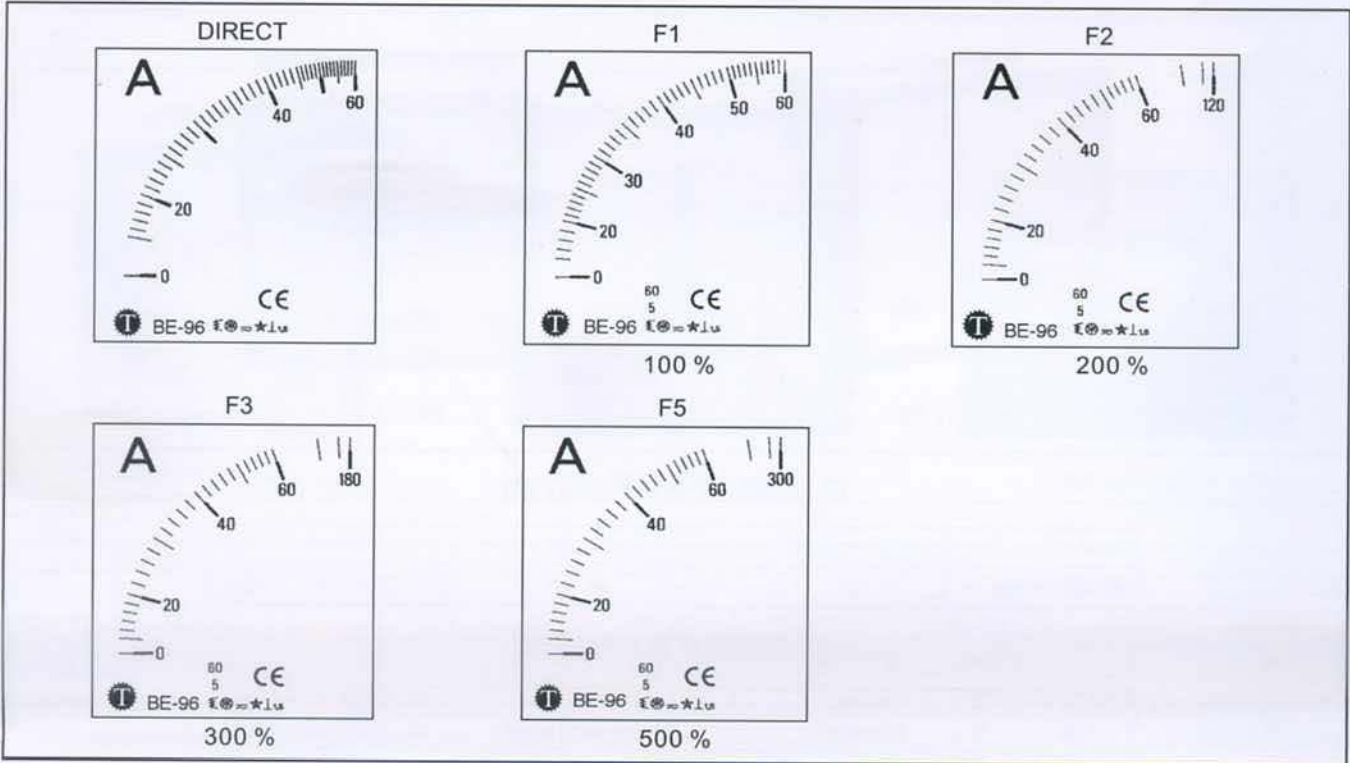

DIRECT		F1 (A)	F2 (A)	F3 (A)
1	1/2	1	1/2	1/3
5	5/10	5	5/10	5/15
10	10/20	10	10/20	10/30
15	15/30	15	15/30	15/45
20	20/40	20	20/40	20/60
25	25/50	25	25/50	25/75
30	30/60	30	30/60	30/90
40	40/80	40	40/80	40/120
50	50/100	50	50/100	50/150
60	60/120	60	60/120	60/180
80	80/160	80	80/160	80/240
100	100/200	100	100/200	100/300
		120	120/240	120/360
		150	150/300	150/450
		200	200/400	200/600
		250	250/500	250/750
		300	300/600	300/900
		400	400/800	400/1200
		500	500/1000	500/1500
		600	600/1200	600/1800
		800	800/1600	800/2400
		1000	1000/2000	1000/3000
		1250	1250/2500	1250/3750
		1500	1500/3000	1500/4500
		2000	2000/4000	2000/6000
		2500	2500/5000	2500/7500
		3000	3000/6000	3000/9000

REEDS/POINTER, FREQUENCY METERS



BE-48/72/96

BE-72/96

IF SERIES BY POINTER

Type	Frequency Hz	Range	Voltage
BE48/72/96/144	50/60	45~65	110V-220V-380V $\pm 15\%$

IF SERIES BY REEDS

BE-72	7 reeds	1 cycle each reed	47~53Hz 57~63Hz
BE-96	11 reeds	1 cycle each reed	45~55Hz 55~65Hz

MAXIMUM DEMAND, BIMETALLIC PANEL METER

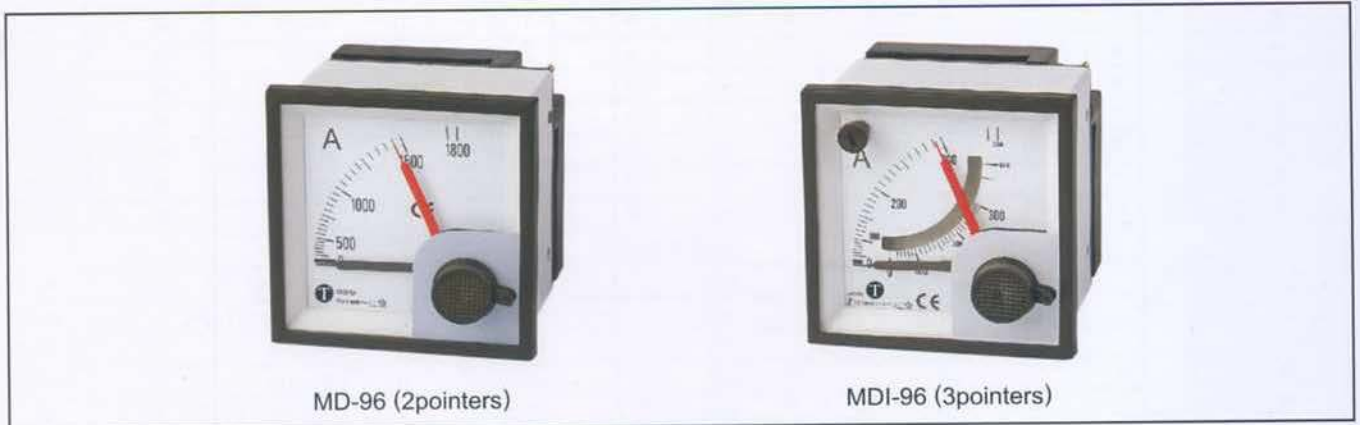

MD-96 (2pointers)

MDI-96 (3pointers)

Bimetallic (Maximum Demand) Panel Meter are designed for testing thermal load If transformers, cables, electrical machines, etc. They can indicate average rms current value in a setting period of 15 minutes.

IF SERIES BY POINTER

 BIMETALLIC (MAXIMUM DEMAND) AMMETES		
Type	DELAY TIME	ON C.T. RATIO / 5A
BE-96 BE-72	15 minutes	10A, 15A, 25A, 40A, 60A, 100A, 150A, 250A, 400A, 600A, 1000A~

POWER FACTOR METER (COS ϕ METERS)



		COS ϕ METERS				
		Type				
	Scale	BP-80	BP-100S	BE-72	BE-96	BE-144
Single phase	90°	•	•	•	•	•
	240°			•	•	
Three phase unbalanced (ARON) 3 wires	90°	•	•	•	•	•
	240°			•	•	
Three phase unbalanced (RIGHI) 4 wires	90°	•	•	•	•	•

Full scale instrument value:	10 - 0 - 10 mA	per COS ϕ 0.5 ÷ 1 ÷ 0.5
Nominal current:	1 1A 5 5A (to be specified)	
Nominal voltage:	0-450V	
Auxiliary voltage:	A 110V B 220V F 380V G 440V	c.c./ A.C.
	C 24V D 48V E 110V	c.c./ D.C.

GENERAL FEATURES

The phasemeters are composed by a reading instrument and a static transducer accessory galvanically insulated S3PD series, to be placed between the line and the instrument.

For further technical details please see our catalogue for transducers.

The transducer is foreseen with auxiliary power supply, so it can work with voltage from zero to the max. value, and the output signal will change proportionally to changing of the current and of the voltage.

PANEL AMMETERS AND VOLTMETERS



FOR A.C.												
AMMETERS												
Type	BP-50S		BP-60		BP-65		BP-670		BP-80		BP-100S	
Size	50×50		60×60		65×65		70×60		80×80		100×80	
(A)	direct	from C.T. 5A	direct	from C.T. 5A	direct	from C.T. 5A	direct	from C.T. 5A	direct	from C.T. 5A	direct	from C.T. 5A
5	•		•		•		•		•		•	
10	•	•	•	•	•	•	•	•	•	•	•	•
20	•	•	•	•	•	•	•	•	•	•	•	•
40		•		•		•		•		•		•
60		•		•		•		•		•		•
100		•		•		•		•		•		•
200		•		•		•		•		•		•
300		•		•		•		•		•		•
500~		•		•		•		•		•		•
VOLTMETERS												
Type	BP-50S		BP-60		BP-65		BP-670		BP-80		BP-100S	
Size	50×50		60×60		65×65		70×60		80×80		100×80	
300V	•		•		•		•		•		•	
500V	•		•		•		•		•		•	
FOR D.C.												
AMMETERS												
Type	BP-50S		BP-60		BP-65		BP-670		BP-80		BP-100	
Size	50×50		60×60		65×65		70×60		80×80		100×80	
(A)	50,60,75mV	1A	50,60,75mV	1A	50,60,75mV	1A	50,60,75mV	1A	50,60,75mV	1A	50,60,75mV	1A
10	•	•	•	•	•	•	•	•	•	•	•	•
20	•	•	•	•	•	•	•	•	•	•	•	•
30	•	•	•	•	•	•	•	•	•	•	•	•
40	•	•	•	•	•	•	•	•	•	•	•	•
60	•	•	•	•	•	•	•	•	•	•	•	•
100 ~	•	•	•	•	•	•	•	•	•	•	•	•
VOLTMETERS												
Type	BP-50S		BP-60		BP-65		BP-670		BP-80		BP-100S	
Size	50×50		60×60		65×65		70×60		80×80		100×80	
40V	•		•		•		•		•		•	
60V	•		•		•		•		•		•	
100V	•		•		•		•		•		•	
200V	•		•		•		•		•		•	
300V	•		•		•		•		•		•	
500V	•		•		•		•		•		•	

WATTMETERS (active power)



BE-72/96/144

BE-72/96/144

BP-65/80/100S

WATTMETERS							
	Scale	Type					
		BP-65	BP-80	BP-100S	BE-72	BE-96	BE-144
Single phase	90°	•	•	•	•	•	•
	240°				•	•	
Three phase unbalanced (ARON) 3 wires	90°	•	•	•	•	•	•
	240°				•	•	
Three phase unbalanced (RIGHI) 4 wires	90°	•	•	•	•	•	•
	240°				•	•	

Full scale instrument value:	10mA
Nominal current:	<input type="checkbox"/> 1A <input type="checkbox"/> 5A (to be specified)
Nominal voltage:	0-450V
Auxiliary voltage:	<input type="checkbox"/> A 110V <input type="checkbox"/> B 220V <input type="checkbox"/> F 380V <input type="checkbox"/> G 440V c.c./A.C. <input type="checkbox"/> C 24V <input type="checkbox"/> D 48V <input type="checkbox"/> E 110V c.c./D.C.
The full scale value must be >20% of the nominal power	

VARMETERS (reactive power)



VARMETERS							
	Scale	Type					
		BP-65	BP-80	BP-100S	BE-72	BE-96	BE-144
Single phase	90°	•	•	•	•	•	•
	240°				•	•	
Three phase unbalanced (ARON) 3 wires	90°	•	•	•	•	•	•
	240°				•	•	
Three phase unbalanced (RIGHI) 4 wires	90°	•	•	•	•	•	•
	240°				•	•	

Full scale instrument value:	10mA
Nominal current:	<input type="checkbox"/> 1A <input type="checkbox"/> 5A (to be specified)
Nominal voltage:	0-450V
Auxiliary voltage:	<input type="checkbox"/> A 110V <input type="checkbox"/> B 220V <input type="checkbox"/> F 380V <input type="checkbox"/> G 440V c.c./A.C. <input type="checkbox"/> C 24V <input type="checkbox"/> D 48V <input type="checkbox"/> E 110V c.c./D.C.
The full scale value must be >20% of the nominal power	

ANALOG METER RELAY

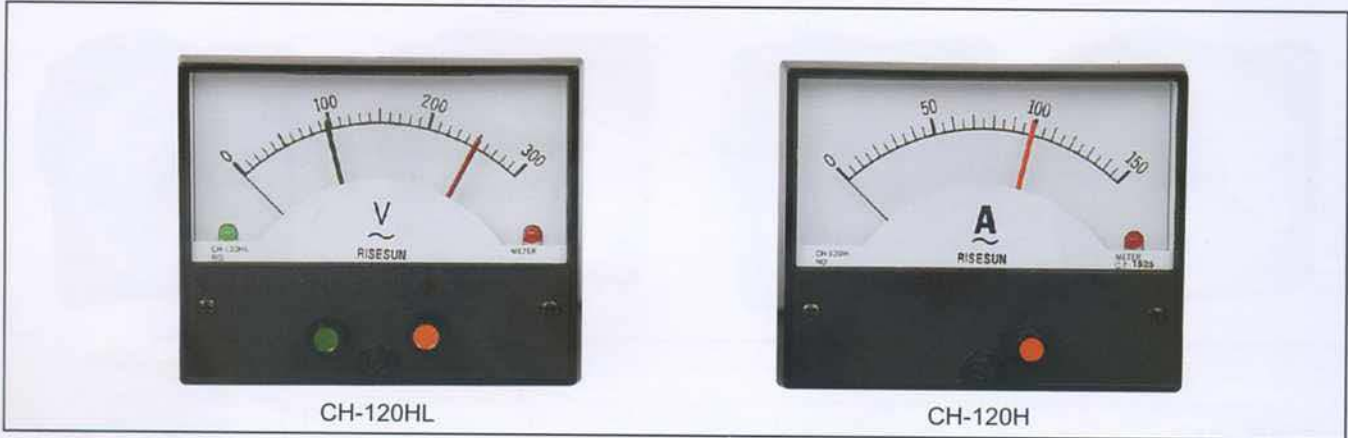

MODEL No.	CONTACTS
CH-120HL CH-100HL	Both high and low contacts standard
CH-120H CH-100H	One high or one low or one high and one low or two high

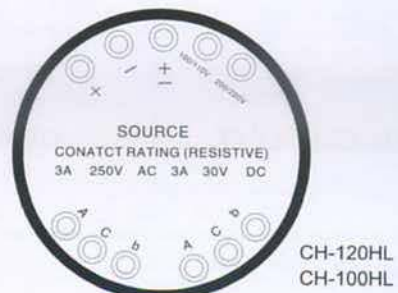

WIRING DIAGRAM

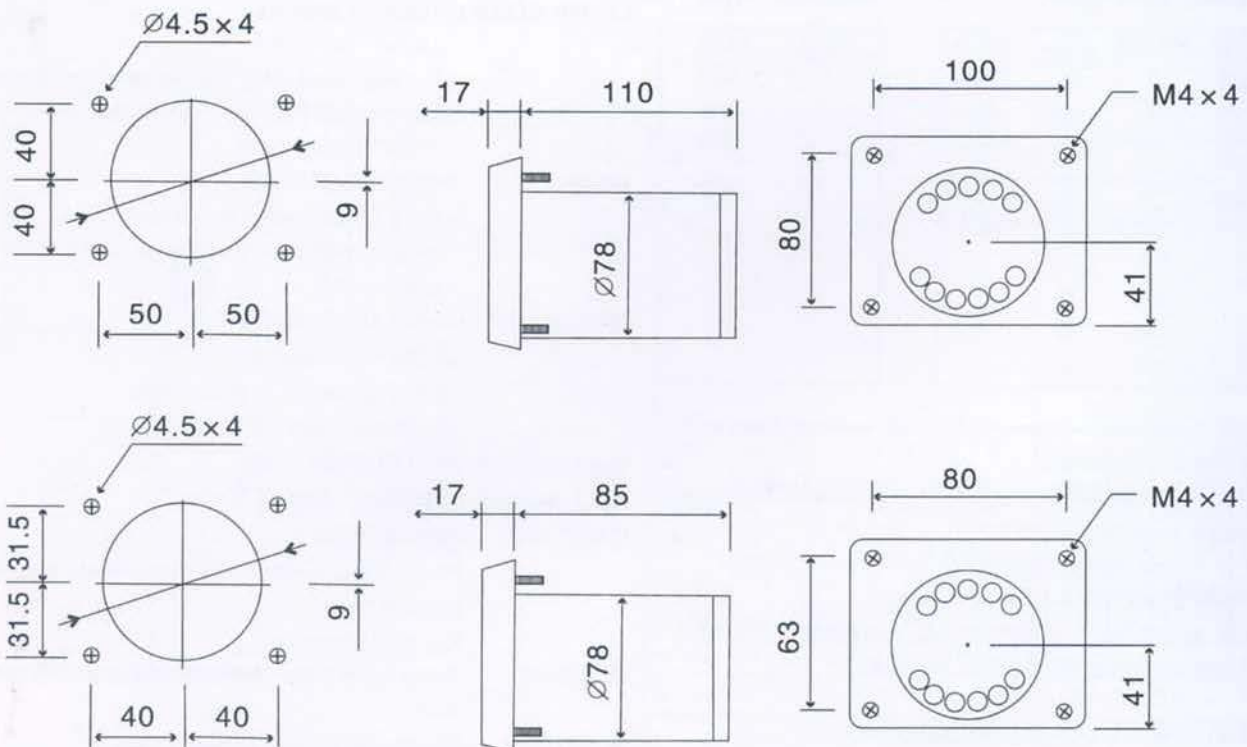

LONG SCALE INSTRUMENT

LS-110A/V



LS-110 KW



LS-110 COS φ



LS-110 Hz

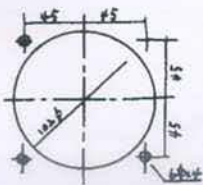

PANEL CUT-OUT

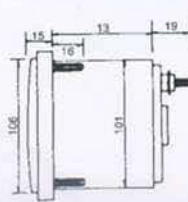

GENERAL DIMENSION

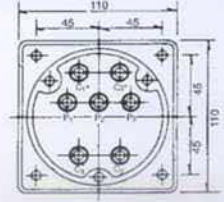
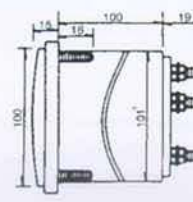
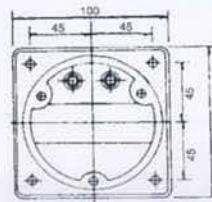

DIMENSION FOR LS-110 KW

mm

MEASURING RANGES:

LS-110A / V :

Moving Coil Type

DC uA	DC mA	DC A	DC V
500	1	1	30
	2	1.5	50
	5	2	100
	10	3	150
	20	5	300
	50	10	
	100	15	
	200	20	
	500	30	

Rectifier Type :

AC A	AC V
1	150
5	300
	500
	600

- For ranges higher than 30A DC, use external shunt with a 50mV DC ammeter.
- For ranges higher than 300V DC, use external Multiplier with a 1 mA Voltmeter.
- For ranges higher than 5A AC, use external Current Transformer with a 5A AC Ammeter.
- For ranges higher than 600V AC, use external Potential Transformer with a 150V AC Voltmeter.

LS-110KW : 110V,220V,380V,500V.1A,5A.

- For any rating other than listed above. use external Current transformer and/or external Potential Transformer with a 110V/5A instrument.

LS-110 COS φ : 110V,220V,380V,500V. 1A,5A.

- For any rating other than those listed above. use external Potential Transformer with a 110B/5A instrument.

LS-Hz : 110V,220V,380V,500V.

- For a voltage rating higher than above, use an external Potential Transformer with a 110V instrument.

ACCURACY : LS-110 A/V-Class 1.5

LS-110 KW-Class 1.5

LS-110 COS φ -4° in [hase angle.

LS-110 Hz-Class 1.5

FULL SCALE DEFLECTION : 250°

FULL SCALE LENGTH : 183MM, 7 1/4"

CASE AND COMPOSITION :

Acrylic Resin cover, plastic meter body, bakelite terminal plate.

four stud mounting.

COLOUR : White scale plate, black terminal plate. grey meter body.

POINTER : Sword type in black colour.

OVERALL DIMENSIONS

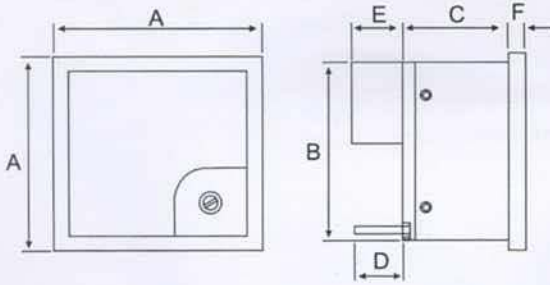

Size	A	B	C	D	E	F	Hole
BE-48	48	44	39	17	20	5.5	46×46
BE-144	144	136	144	17	20	7	140×140

mm

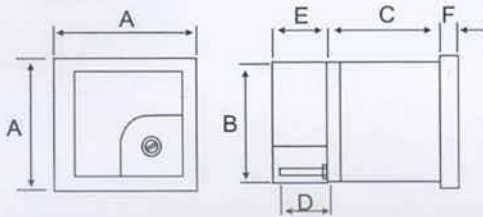

Size	A	B	C	D	E	F	Hole
BE-72	72	66	36.5	17	17.5	5.5	68×68
BE-96	96	90	45	17	17.5	6	92×92

mm

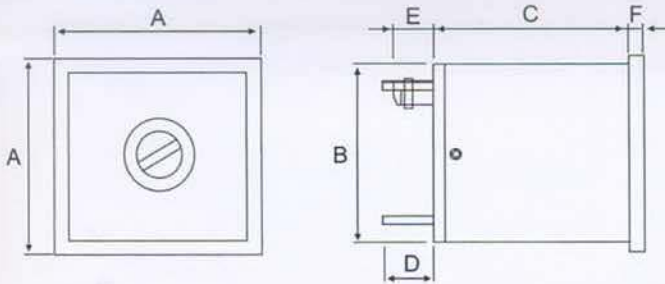

Size	A	B	C	D	E	F	Hole
BE-72	73	66	68	17	13	6.5	68×68
BE-96L	96.5	90	45	17	13	6	92×92

mm

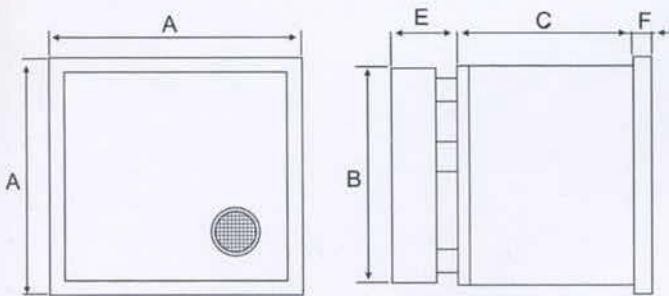

Size	A	B	C	E	F	Hole
BE-96B	96	90	68	24	8	92×92

mm

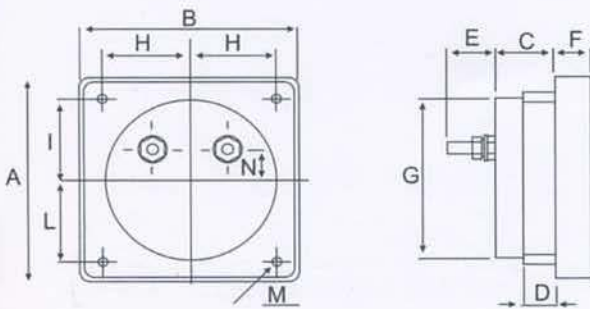

Size	A	B	C	D	E	F	G	H	I	L	M	N	For Hole
BP-50S	50	52	23.5	13.5	4.4	12.5	45	19	19	19	3.5	15	46
BP-60	60	60	24	11	9.5	11	52	24	24	24	3.5	4	53
BP-65	67	67	24	11	10	13	52.5	25.5	25.5	25.5	3.5	4	53.5
BP-670	60	70	25.5	13	10	11	52.5	24	24	24	3.5	5	53
BP-80	81	81	22	12	18.5	13.5	63.5	32.5	32.5	32.5	3.5	12	65
BP-100S	80	100	25	13.5	11	14	64	41.5	36.5	27.5	3.5	4	65

mm

INDEX

- *PASSING CABLE CURRENT TRANSFORMERS* 15
- *CURRENT TRANSFORMER : TAB* 16
- *CURRENT TRANSFORMER : CTP* 17
- *CURRENT TRANSFORMER : SCT* 18
- *CURRENT TRANSFORMER : MFO* 19
- *CURRENT TRANSFORMER : ECT , RCT* 20
- *MR CURRENT TRANSFORMERS* 21
- *ACCESSORIES* 22
- *SPLIT CORE CURRENT TRANSFORMERS* 23
- *SHUNT FOR D.C.* 24

The Company can modify the specification at any time without having to give notice.

PASSING CABLE CURRENT TRANSFORMERS

	<p>TAF 1</p> <table border="1"> <tr> <td>Cable ϕ</td> <td colspan="2">22 mm</td> </tr> </table> <table border="1"> <thead> <tr> <th rowspan="2">Primary current</th> <th colspan="2">burden</th> </tr> <tr> <th>cl.0,5</th> <th>cl.1,0</th> </tr> </thead> <tbody> <tr> <td>/5A</td> <td>VA</td> <td>VA</td> </tr> <tr> <td>40</td> <td></td> <td>1</td> </tr> <tr> <td>50</td> <td></td> <td>1</td> </tr> <tr> <td>60</td> <td></td> <td>1</td> </tr> <tr> <td>80</td> <td>1,5</td> <td>3</td> </tr> <tr> <td>100</td> <td>1,5</td> <td>3</td> </tr> <tr> <td>150</td> <td>1,5</td> <td>3</td> </tr> </tbody> </table>	Cable ϕ	22 mm		Primary current	burden		cl.0,5	cl.1,0	/5A	VA	VA	40		1	50		1	60		1	80	1,5	3	100	1,5	3	150	1,5	3															
Cable ϕ	22 mm																																												
Primary current	burden																																												
	cl.0,5	cl.1,0																																											
/5A	VA	VA																																											
40		1																																											
50		1																																											
60		1																																											
80	1,5	3																																											
100	1,5	3																																											
150	1,5	3																																											
	<p>TAF 2</p> <table border="1"> <tr> <td>Cable ϕ</td> <td>bus bar</td> <td></td> </tr> <tr> <td>23 mm</td> <td>30×10mm</td> <td></td> </tr> <tr> <td></td> <td>25×12.5mm</td> <td></td> </tr> <tr> <td></td> <td>20×15mm</td> <td></td> </tr> </table> <table border="1"> <thead> <tr> <th rowspan="2">Primary current</th> <th colspan="2">burden</th> </tr> <tr> <th>cl.0,5</th> <th>cl.1,0</th> </tr> </thead> <tbody> <tr> <td>/5A</td> <td>VA</td> <td>VA</td> </tr> <tr> <td>60</td> <td></td> <td>1</td> </tr> <tr> <td>80</td> <td></td> <td>1</td> </tr> <tr> <td>100</td> <td></td> <td>1</td> </tr> <tr> <td>150</td> <td></td> <td>1</td> </tr> <tr> <td>200</td> <td>1,5</td> <td>3</td> </tr> <tr> <td>250</td> <td>1,5</td> <td>3</td> </tr> <tr> <td>300</td> <td>1,5</td> <td>3</td> </tr> <tr> <td>400</td> <td>2</td> <td>3</td> </tr> </tbody> </table>	Cable ϕ	bus bar		23 mm	30×10mm			25×12.5mm			20×15mm		Primary current	burden		cl.0,5	cl.1,0	/5A	VA	VA	60		1	80		1	100		1	150		1	200	1,5	3	250	1,5	3	300	1,5	3	400	2	3
Cable ϕ	bus bar																																												
23 mm	30×10mm																																												
	25×12.5mm																																												
	20×15mm																																												
Primary current	burden																																												
	cl.0,5	cl.1,0																																											
/5A	VA	VA																																											
60		1																																											
80		1																																											
100		1																																											
150		1																																											
200	1,5	3																																											
250	1,5	3																																											
300	1,5	3																																											
400	2	3																																											
	<p>TAF 3</p> <table border="1"> <tr> <td>bus bar</td> <td colspan="2"></td> </tr> <tr> <td>40×10mm</td> <td colspan="2"></td> </tr> <tr> <td>30×20mm</td> <td colspan="2"></td> </tr> <tr> <td>25×25mm</td> <td colspan="2"></td> </tr> </table> <table border="1"> <thead> <tr> <th rowspan="2">Primary current</th> <th colspan="2">burden</th> </tr> <tr> <th>cl.0,5</th> <th>cl.1,0</th> </tr> </thead> <tbody> <tr> <td>/5A</td> <td>VA</td> <td>VA</td> </tr> <tr> <td>200</td> <td>2</td> <td>4</td> </tr> <tr> <td>250</td> <td>2,5</td> <td>5</td> </tr> <tr> <td>300</td> <td>4</td> <td>6</td> </tr> <tr> <td>400</td> <td>5</td> <td>8</td> </tr> <tr> <td>500</td> <td>6</td> <td>10</td> </tr> <tr> <td>600</td> <td>6</td> <td>12</td> </tr> <tr> <td>800</td> <td>8</td> <td>15</td> </tr> <tr> <td>1000</td> <td>10</td> <td>20</td> </tr> </tbody> </table>	bus bar			40×10mm			30×20mm			25×25mm			Primary current	burden		cl.0,5	cl.1,0	/5A	VA	VA	200	2	4	250	2,5	5	300	4	6	400	5	8	500	6	10	600	6	12	800	8	15	1000	10	20
bus bar																																													
40×10mm																																													
30×20mm																																													
25×25mm																																													
Primary current	burden																																												
	cl.0,5	cl.1,0																																											
/5A	VA	VA																																											
200	2	4																																											
250	2,5	5																																											
300	4	6																																											
400	5	8																																											
500	6	10																																											
600	6	12																																											
800	8	15																																											
1000	10	20																																											
	<p>TAC 1</p> <table border="1"> <tr> <td>Cable ϕ</td> <td>bus bar</td> <td></td> </tr> <tr> <td>23 mm</td> <td>30×10mm</td> <td></td> </tr> <tr> <td></td> <td>25×12.5mm</td> <td></td> </tr> <tr> <td></td> <td>20×15mm</td> <td></td> </tr> </table> <table border="1"> <thead> <tr> <th rowspan="2">Primary current</th> <th colspan="2">burden</th> </tr> <tr> <th>cl.0,5</th> <th>cl.1,0</th> </tr> </thead> <tbody> <tr> <td>/5A</td> <td>VA</td> <td>VA</td> </tr> <tr> <td>40</td> <td></td> <td>1</td> </tr> <tr> <td>50</td> <td></td> <td>1</td> </tr> <tr> <td>60</td> <td></td> <td>1</td> </tr> <tr> <td>80</td> <td>1,5</td> <td>3</td> </tr> <tr> <td>100</td> <td>1,5</td> <td>3</td> </tr> <tr> <td>150</td> <td>1,5</td> <td>3</td> </tr> </tbody> </table>	Cable ϕ	bus bar		23 mm	30×10mm			25×12.5mm			20×15mm		Primary current	burden		cl.0,5	cl.1,0	/5A	VA	VA	40		1	50		1	60		1	80	1,5	3	100	1,5	3	150	1,5	3						
Cable ϕ	bus bar																																												
23 mm	30×10mm																																												
	25×12.5mm																																												
	20×15mm																																												
Primary current	burden																																												
	cl.0,5	cl.1,0																																											
/5A	VA	VA																																											
40		1																																											
50		1																																											
60		1																																											
80	1,5	3																																											
100	1,5	3																																											
150	1,5	3																																											

CURRENT TRANSFORMER

	<p>TAB 0</p> <table border="1"> <tr> <td>Cable ϕ</td> <td colspan="2">burden</td> </tr> <tr> <td>22 mm</td> <td>cl.0,5</td> <td>cl.1,0</td> </tr> <tr> <td>/5A</td> <td>VA</td> <td>VA</td> </tr> <tr> <td>40</td> <td>-</td> <td>1</td> </tr> <tr> <td>50</td> <td>-</td> <td>1,5</td> </tr> <tr> <td>60</td> <td>-</td> <td>1,5</td> </tr> <tr> <td>80</td> <td>-</td> <td>2</td> </tr> <tr> <td>100</td> <td>2</td> <td>4</td> </tr> <tr> <td>150</td> <td>3</td> <td>6</td> </tr> <tr> <td>200</td> <td>4</td> <td>8</td> </tr> <tr> <td>250</td> <td>5</td> <td>10</td> </tr> </table>	Cable ϕ	burden		22 mm	cl.0,5	cl.1,0	/5A	VA	VA	40	-	1	50	-	1,5	60	-	1,5	80	-	2	100	2	4	150	3	6	200	4	8	250	5	10																											
Cable ϕ	burden																																																												
22 mm	cl.0,5	cl.1,0																																																											
/5A	VA	VA																																																											
40	-	1																																																											
50	-	1,5																																																											
60	-	1,5																																																											
80	-	2																																																											
100	2	4																																																											
150	3	6																																																											
200	4	8																																																											
250	5	10																																																											
	<p>TAB 1</p> <table border="1"> <tr> <td>Cable ϕ</td> <td>bus bar <input type="checkbox"/></td> <td colspan="2">burden</td> </tr> <tr> <td>23 mm</td> <td>30x10mm</td> <td>cl.0,5</td> <td>cl.1,0</td> </tr> <tr> <td>/5A</td> <td></td> <td>VA</td> <td>VA</td> </tr> <tr> <td>50</td> <td></td> <td>-</td> <td>1</td> </tr> <tr> <td>60</td> <td></td> <td>-</td> <td>1</td> </tr> <tr> <td>80</td> <td></td> <td>-</td> <td>1,5</td> </tr> <tr> <td>100</td> <td></td> <td>-</td> <td>1,5</td> </tr> <tr> <td>150</td> <td></td> <td>1</td> <td>2</td> </tr> <tr> <td>200</td> <td></td> <td>2</td> <td>4</td> </tr> <tr> <td>250</td> <td></td> <td>3</td> <td>6</td> </tr> <tr> <td>300</td> <td></td> <td>3</td> <td>6</td> </tr> <tr> <td>400</td> <td></td> <td>5</td> <td>10</td> </tr> <tr> <td>500</td> <td></td> <td>8</td> <td>12</td> </tr> <tr> <td>600</td> <td></td> <td>10</td> <td>15</td> </tr> </table>	Cable ϕ	bus bar <input type="checkbox"/>	burden		23 mm	30x10mm	cl.0,5	cl.1,0	/5A		VA	VA	50		-	1	60		-	1	80		-	1,5	100		-	1,5	150		1	2	200		2	4	250		3	6	300		3	6	400		5	10	500		8	12	600		10	15				
Cable ϕ	bus bar <input type="checkbox"/>	burden																																																											
23 mm	30x10mm	cl.0,5	cl.1,0																																																										
/5A		VA	VA																																																										
50		-	1																																																										
60		-	1																																																										
80		-	1,5																																																										
100		-	1,5																																																										
150		1	2																																																										
200		2	4																																																										
250		3	6																																																										
300		3	6																																																										
400		5	10																																																										
500		8	12																																																										
600		10	15																																																										
	<p>TAB 2</p> <table border="1"> <tr> <td>Cable ϕ</td> <td>bus' bar <input type="checkbox"/></td> <td colspan="2">burden</td> </tr> <tr> <td>33 mm</td> <td>40x10mm</td> <td>cl.0,5</td> <td>cl.1,0</td> </tr> <tr> <td></td> <td>35x10mm</td> <td></td> <td></td> </tr> <tr> <td></td> <td>25x10mm</td> <td></td> <td></td> </tr> <tr> <td>/5A</td> <td></td> <td>VA</td> <td>VA</td> </tr> <tr> <td>100</td> <td></td> <td>-</td> <td>2</td> </tr> <tr> <td>150</td> <td></td> <td>1</td> <td>3</td> </tr> <tr> <td>200</td> <td></td> <td>2</td> <td>4</td> </tr> <tr> <td>250</td> <td></td> <td>2,5</td> <td>5</td> </tr> <tr> <td>300</td> <td></td> <td>4</td> <td>6</td> </tr> <tr> <td>400</td> <td></td> <td>5</td> <td>8</td> </tr> <tr> <td>500</td> <td></td> <td>6</td> <td>10</td> </tr> <tr> <td>600</td> <td></td> <td>6</td> <td>12</td> </tr> <tr> <td>800</td> <td></td> <td>8</td> <td>15</td> </tr> <tr> <td>1000</td> <td></td> <td>10</td> <td>20</td> </tr> </table>	Cable ϕ	bus' bar <input type="checkbox"/>	burden		33 mm	40x10mm	cl.0,5	cl.1,0		35x10mm				25x10mm			/5A		VA	VA	100		-	2	150		1	3	200		2	4	250		2,5	5	300		4	6	400		5	8	500		6	10	600		6	12	800		8	15	1000		10	20
Cable ϕ	bus' bar <input type="checkbox"/>	burden																																																											
33 mm	40x10mm	cl.0,5	cl.1,0																																																										
	35x10mm																																																												
	25x10mm																																																												
/5A		VA	VA																																																										
100		-	2																																																										
150		1	3																																																										
200		2	4																																																										
250		2,5	5																																																										
300		4	6																																																										
400		5	8																																																										
500		6	10																																																										
600		6	12																																																										
800		8	15																																																										
1000		10	20																																																										

CURRENT TRANSFORMER



CTP 30/11

CTP 40/11

CTP 50/12

CTP 60/12

CTP 80/12

OUTLINE DRAWING OF CTP30/11 TO CTP80/12

Dimensions in mm.

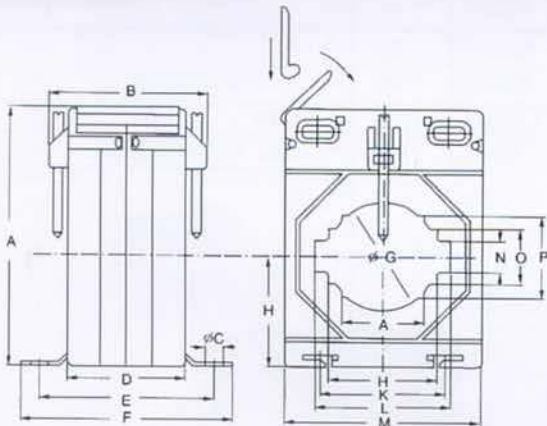

Model	Rated Current (A) Primary/Secondary	Rated burden (VA)	Accuracy Class (CL)	Rated Voltage	Rated Frequency
CTP30/11	50/5A-300/5A	1.5 - 5	1.0 - 05	720V	50/60Hz
CTP40/11	150/5A-800/5A	1.5 - 10	1.0 - 05	720V	50/60Hz
CTP50/12	250/5A-1000/5A	5 - 10	1.0 - 05	720V	50/60Hz
CTP60/12	250/5A-1500/5A	5 - 10	1.0 - 05	720V	50/60Hz
CTP80/12	300/5A-2000/5A	5 - 15	1.0 - 05	720V	50/60Hz

OUTLINE DRAWING OF CTP-14

Dimensions in mm.

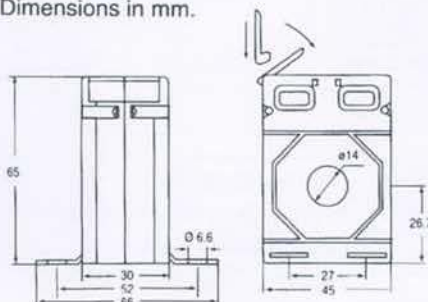

Secondary current: 5A Security Factor:FS-5
 Frequency: 50-60Hz High voltage test: 4KV_{eff}, 50Hz, 1min
 Rated voltage: 720V Weight: 200-250gr

Rated Current(A) Primary/Secondary	30/5A-40/5A	50/5A	60/5A	75/5A-80/5A	100/5A
Accuracy Class	3	1.0	1.0	1.0	1.0
burden(VA)	1	1	1.5	1.5	1.5

CURRENT TRANSFORMER



SCT-30



SCT-40



SCT-60



SCT-100

This type current transformer is made according to BS3938 with ABS non-combustible plastic case.

Outline drawing of SCT.TYPE

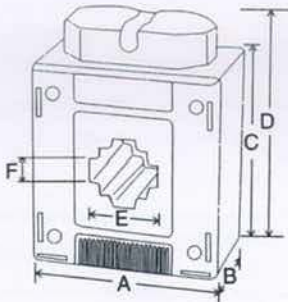

Model	Rated Current (A) Primary / Secondary	Busbar Hole Dimension (mm)	Rated burden (VA)	Accuracy Class (CL)	Rated Voltage	Rated Frequency
SCT-30	50/5A-300/5A	30×10	1-7.5	0.5 1.0	660V	50/60Hz
SCT-40	200/5A-800/5A	40×10	5-10	0.5 1.0	660V	50/60Hz
SCT-60	400/5A-1200/5A	60×20	10-15	0.5 1.0	660V	50/60Hz
SCT-100	1000/5A-3000/5A	100×20	10-15	0.5 1.0	660V	50/60Hz

Model	A	B	C	D	E	F
SCT-30	85	53	95	112	30	10
SCT-40	85	53	95	112	40	10
SCT-60	111	53	131	148	60	20
SCT-100	155	53	174	192	100	20

OUTLINE DRAWING OF CTP100/31

Dimensions in mm.

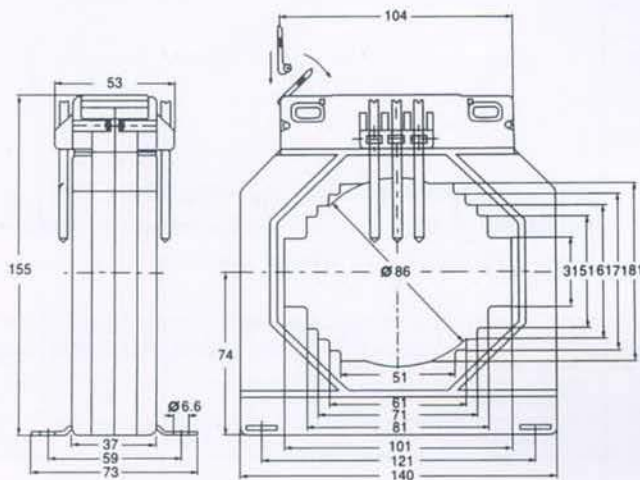

CTP100/31

Rated current(A)
 Primary/Secondary current: 1000/5A-4000/5A
 Rated burden: 15VA-40VA
 Accuracy Class: 0.2-1.0
 Rated voltage: 720V
 Operating frequency: 50-60Hz

CURRENT TRANSFORMERS FOR AMMETERS. (LOW VOLTAGE)



MFO-30



MFO-40



MFO-60



MFO-100

MOTD	MFO-30	MFO-40	MFO-60	MFO-100
RATIO	POWER CLASS	POWER CLASS	POWER CLASS	POWER CLASS
50/5A	2VA* 1A			
60/5A	2VA* 1A			
75/5A	2,5VA* 1A			
100/5A	2,5VA* 1A			
125/5A	2,5VA* 1A			
150/5A	3VA* 1A			
200/5A	5VA 1	3VA* 1A		
250/5A	5VA 1	3VA* 1A		
300/5A	5VA 1	5VA 1		
400/5A	5VA 1	5VA 1		
500/5A	5VA 1	5VA 1	7,5VA 1	
600/5A			7,5VA 1	
700/5A			7,5VA 1	
750/5A			7,5VA 1	
800/5A			7,5VA 1	
1000/5A			7,5VA 1	10VA 1
1200/5A			10VA 1	10VA 1
1500/5A			10VA 1	10VA 1
2000/5A				10VA 1
2500/5A				10VA 1
3000/5A				10VA 1

MFO-100

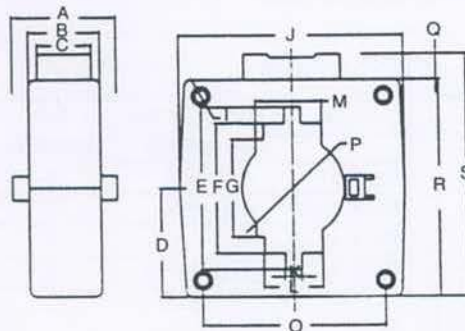

MFO-30~MFO-60

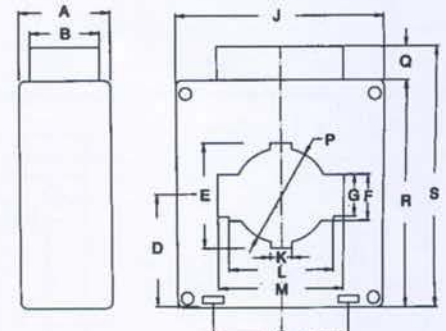

ITEM NO.	PRIMARY / SECONDARY (A)	WINDOW DIMENSION	PCOAD (VA)	ACCURACY CLASS	RATED VOLTAGE
MFO-30	30/5A-500/5A	30X10mm	2.5	1.0	600V
MFO-40	30/5A-500/5A	40X10mm	5	1.0	600V
MFO-60	400/5A-800/5A	60X20mm	10	1.0	600V
MFO-100	800/5A-3000/5A	100X10mm	15	1.0	600V

CURRENT TRANSFORMER



ECT-30

ECT-30A

ECT-30 Indoor cast-resin insulated CT

Primary current: 30-300A
 Secondary current: 5A
 Frequency: 50-60Hz
 Rated burden: 10VA, 15VA
 Class: 0.2, 0.5s, 0.5, 1.0

ECT-30A Indoor cast-resin insulated CT

Primary current: 30-200A
 Secondary current: 5A
 Frequency: 50-60Hz
 Rated burden: 5VA, 10VA, 15VA
 Class: 0.2, 0.5s, 0.5, 1.0

RCT-15-4



RCT-15-3



RCT-15-2



RCT-15-1

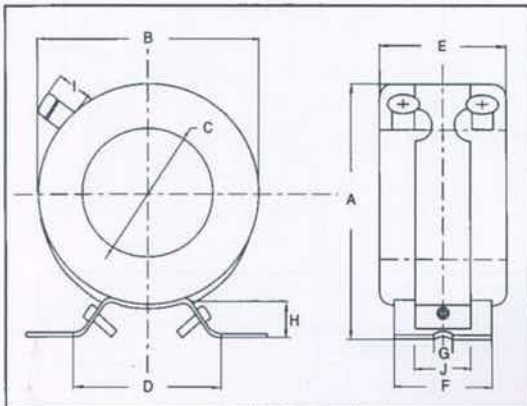

Model	Primary Current Rating(Amp)	Sec Current(A)	Burden (VA)	Accuracy Strength	Power	Weight
RCT-51-1	20~300	5	5~10	1.0	40	0.8
RCT-15-2	400~600	5	15	1.0	40	1
RCT-15-3	800~1200	5	15	1.0	40	1.3
RCT-15-4	1600~3000	5	15	1.0	40	2

Model	A	B	C	D	E	F	G	H	I	J
RCT-15-1	92	78	35	67	55	45	8	17	14	25
RCT-15-2	116	100	60	67	57	45	8	17	15	25.5
RCT-15-3	150	135	91	67	59	45	8	17	15	26.2
RCT-15-4	178	160	110	72	60	45	8	19	16	26.7



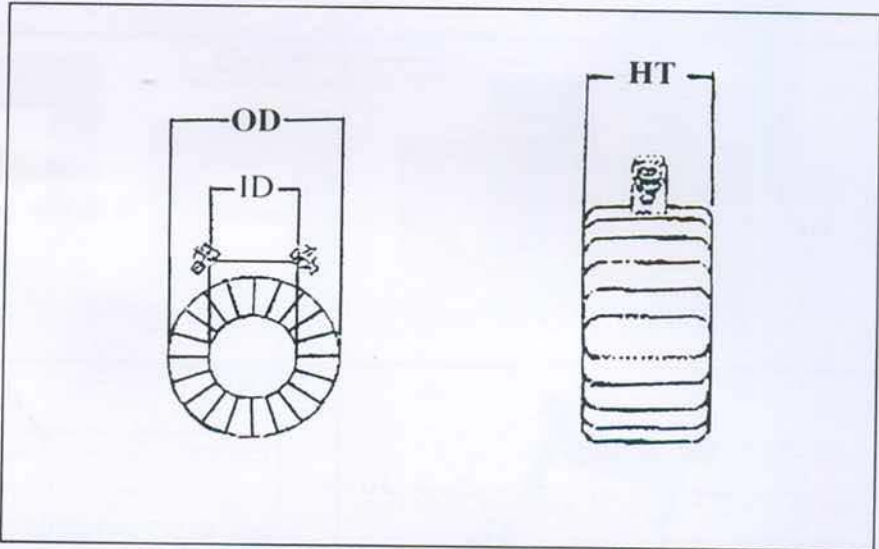

MR CURRENT TRANSFORMERS



MR series:
Class: 0.5 1.0 3.0

TYPE	SPECIFICATION	ID(mm)	OD(mm)	HT(mm)
MR-28	30/5A-60/5A	28	70	40
MR-42	100/5A-250/5A	42	80	30
MR-45	300/5A	45	80	30
MR-60	400/5A-600/5A	60	100	30
MR-85	800/5A-1600/5	85	120	20
MR-125	2000/A-5000/5	125	165	20

ACCESSORIES

	<p>STAB</p> <p>Support for C.T. for DIN rail (MFO)</p>
	<p>STAF</p> <p>Support for C.T. for DIN rail (TAF)</p>
	<p>STAC</p> <p>Adapter for changing in screw the TAF fasten caps.</p>
	<p>STAP</p> <p>Protection for secondary output contacts of TAB-MFO</p>

CONNECTING DRAWING

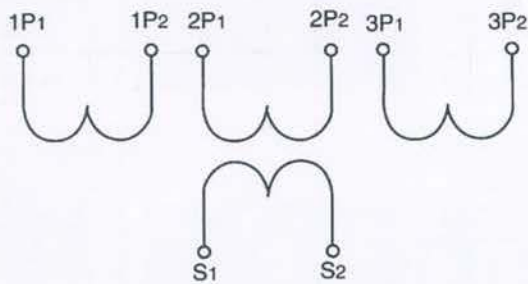
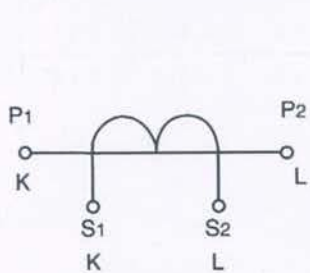

Summating C.T.

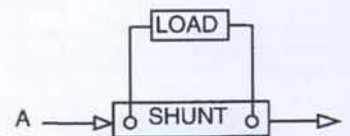

Shunt

SPLIT CORE CURRENT TRANSFORMERS

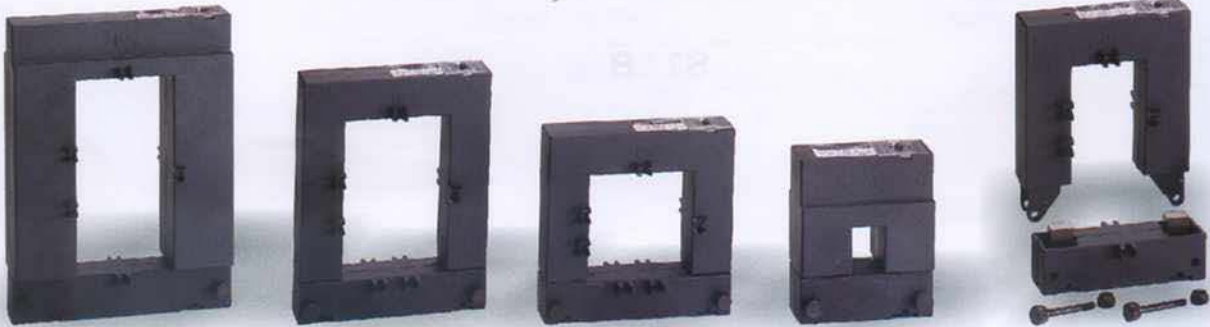

MODEL	PRIMARY CURRENT	CLASS 0.5	CLASS 1	CLASS 3	HOLE DIMENSIONS mm	WEIGHT kg
	A	VA	VA	VA		
RS-23	100	-	-	2	20.0 X 30.0	0.75
	150	-	-	3.75		
	200	-	2.5	4		
	250	-	3.75	5		
RS-58	300	2	3.75	5	50.0 X 80.0	0.90
	400	2.5	3.75	7.5		
	500	3.75	5	15		
	600	5	7.5	20		
RS-88	800	7.5	10	20	80.0 X 80.0	1.25
	1000	10	15	20		
RS-812	1200	15	20	30	80.0 X 120	1.25
	1500	15	20	30		
		20	30	45		
RS-816	2000	25	30	45	80.0 X 160	4.30
	2500					
	3000					
	4000					
	5000					
	6000					

ORDERING INFORMATION

MODEL	RATIO	
RS - 23	100/5A - 250/5A	
RS - 58	300/5A - 600/5A	
RS - 88	800/5A - 1000/5A	5A
RS - 812	1200/5A - 1500/5A	
RS - 816	2000/5A - 6000/5A	

Dimensions (mm's)

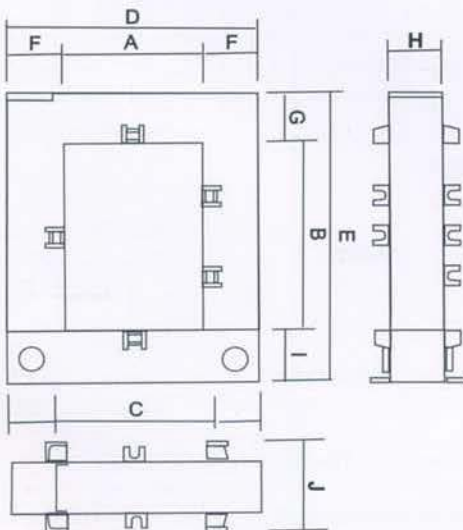

Model	RS-23	RS-58	RS-88	RS-812	RS-846
A	20	50	80	80	80
B	30	80	80	120	160
C	51	78	108	108	120
D	89	114	144	144	184
E	110	145	145	185	245
F	34	32	32	32	52
G	47	32	32	32	47
H	40	32	32	32	52
I	32	33	33	33	38
J	59	-	-	-	-

SHUNT FOR DC METER

GENERAL FEATURES

The shunts are used to reduce the continuous to voltage values that can be read by the measure instruments.

The voltage drop standard values are:

- 50mV
- 60mV
- 75mV
- 100mV

With high connecting distances from instrument, We suggest to use shunt with voltage drop higher than 60mV 50mV.

The shunts are built in manganin with brass support, welded each other using materials containing silver.

Those with voltage drop of 60mV 50mV are tropicalized while for higher values they are passivated.

During use the shunt overheat proportionally to the current that passes through.

For this reason we use one or more manganin bars, to be able to ailow an higher heat dissipation.

For the same reason it is better to palce the shunt horizontally.

Connections must be clean and tightened to be able to avoid connection voltage drops.

TECHNICAL FEATURES

Accuracy class:0,5

Surcharge current: 1,2 In continuous

Surcharge during 5 seconds:

- From 10A to 500A 10In
- From 600A to 2,000A 5In
- From 2,500A to 10,000A 2In

*The ranges indicated are for shunts with output 60 mV 50 mV.
For higer outputs A and B ranges increase respectively:*

Output	A-B
50 mV	26 mm
60 mV	26 mm
75 mV	30 mm

EXAMPLE OF ORDER

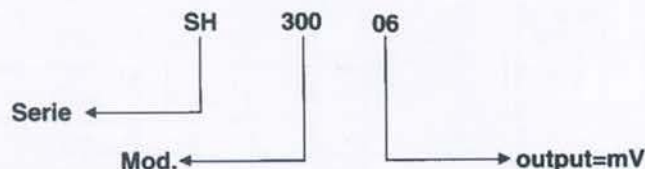

Output 06=60mV, 05=50mV 075=75mV 10=100mV 15=150mV 20=200mV



RS-10 1-150A

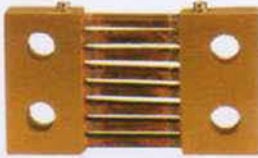

**RS-10 800A, 1000A
1500A**



RS-20 200A

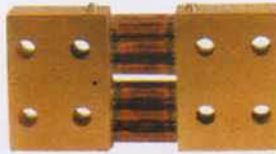

RS-50 2000A

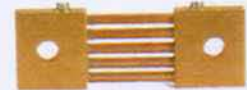

**RS-30 200A, 250A
300A, 600A**



**RS-60 3000A, 4000A
5000A**

RS-10
150A
(140g)
100A

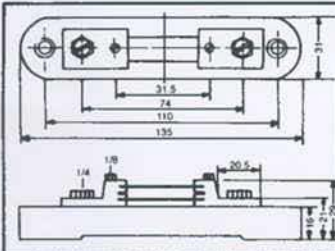

RS-30
400A
(490g)

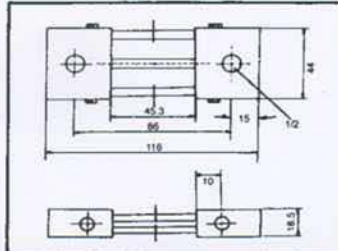

RS-40
1500A
(2.03kg)

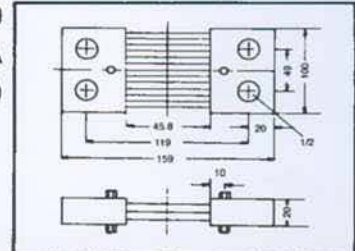

RS-20
200A
(240g)

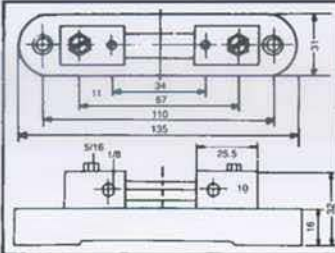

RS-30
500A
(615g)

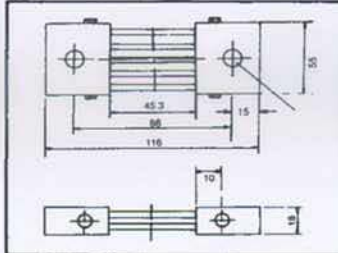

RS-50
2000A
(5.0kg)

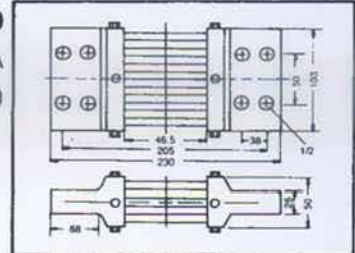

RS-30
200A
(190g)

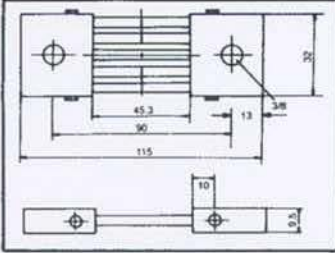

RS-30
600A
(770g)

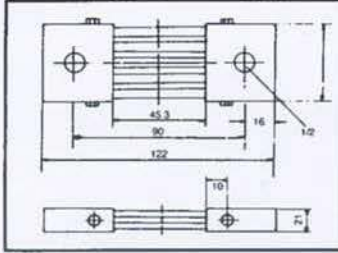

RS-60
3000A
(7.0kg)

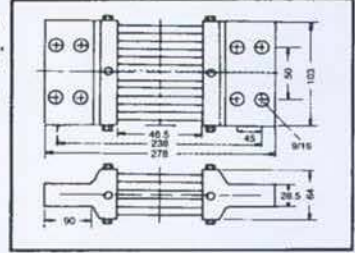

RS-30
250A
(315g)

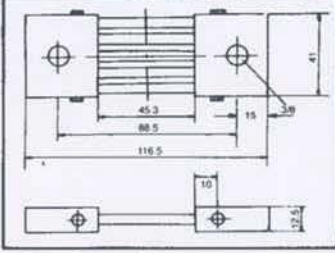

RS-40
800A
(970g)

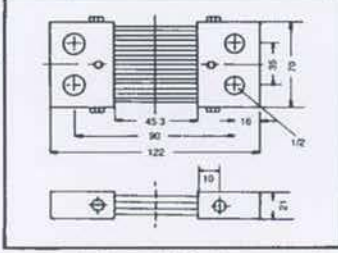

RS-60
4000A
9.45kg)

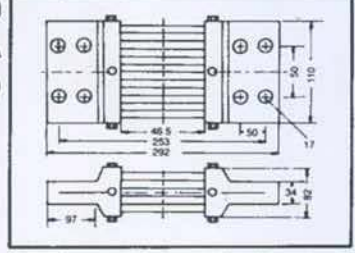

RS-30
300A
(370g)

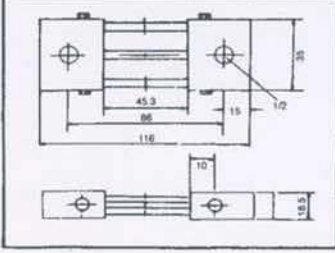

RS-40
1000A
(1400g)

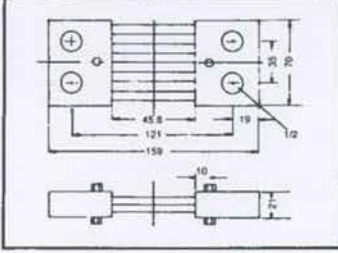

RS-60
5000A
(15.0kg)

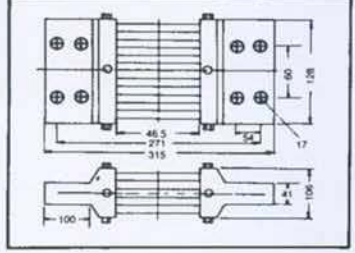

1. Standard Range: 50mV
2. Tolerance on weight and tickness: 5%
3. Specification of MV screws on the part of silver solder: 5/32
4. Other standard for 60mv, 75mv, 100mv solder are available



**MANUFACTURERS
TAIWAN METERS PLANT CO., LTD.**

3F., No.66-11, Sec. 2, Nankan Rd., Lujhu Township,
Taoyuan County 338, Nankan Industrial Park, Taiwan.
TEL : (03) 3117995 (Rep.)
FAX : (03) 3114894
E-mail : taiwan.meters@msa.hinet.net
website : <http://www.taiwanmeters.com.tw/>